

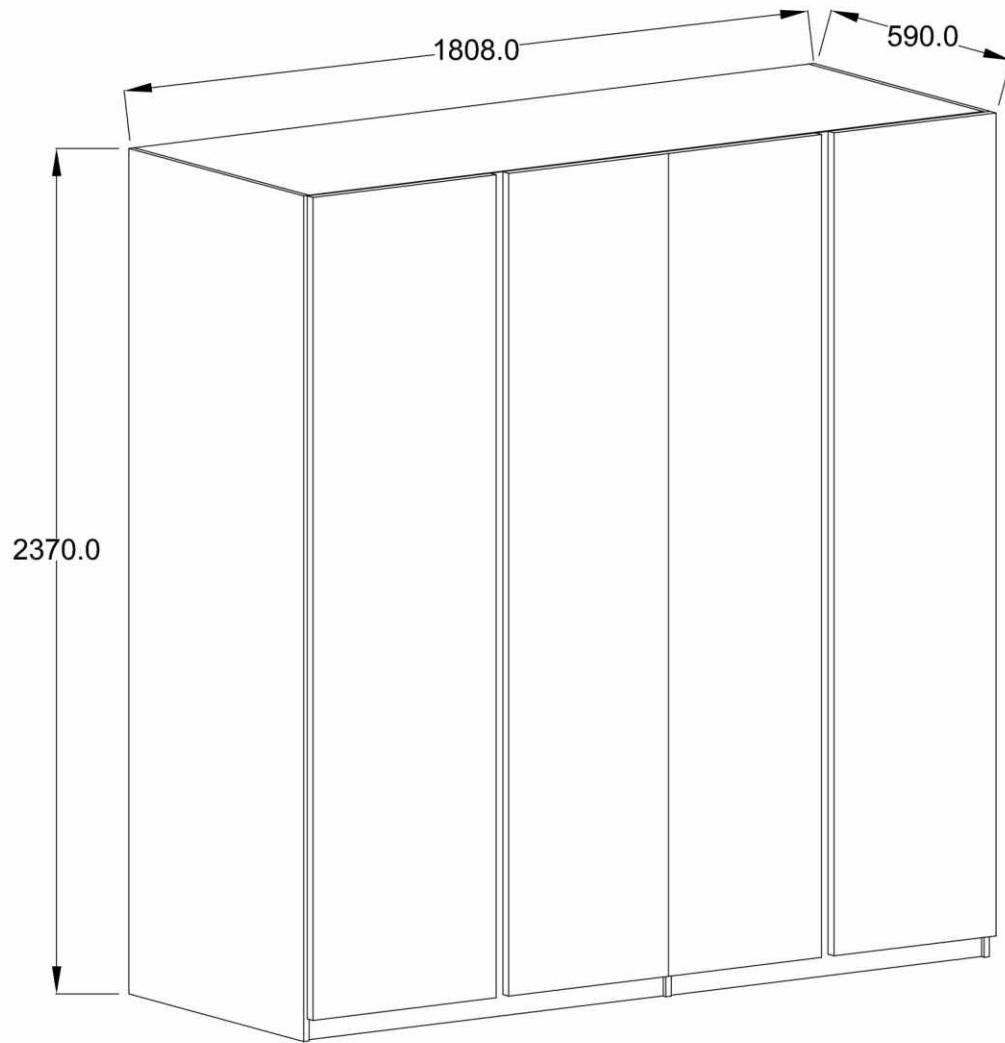

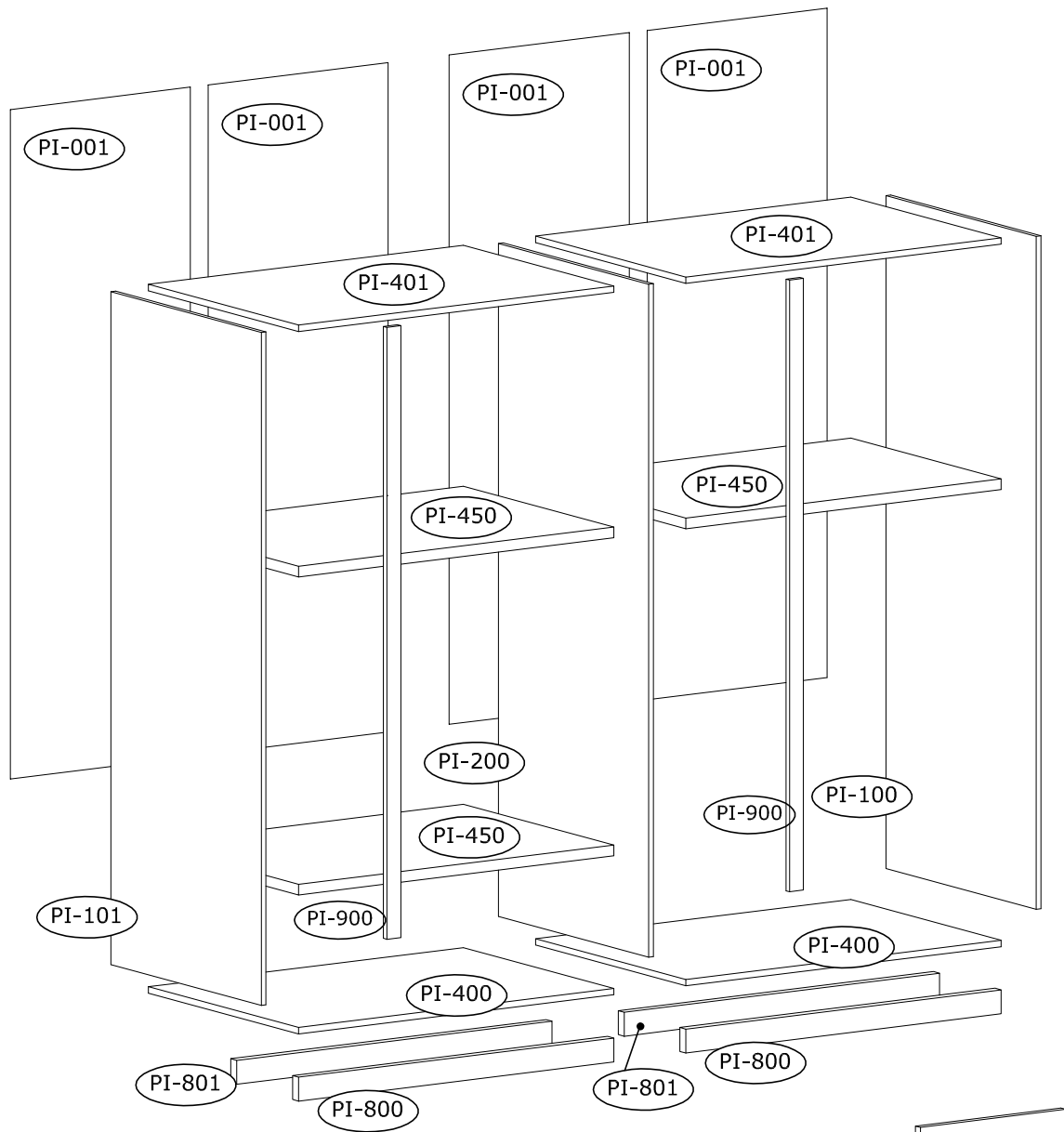

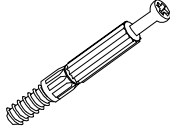

PIETRO

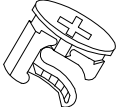
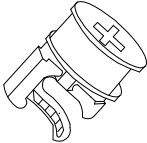
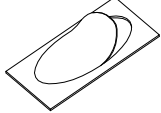
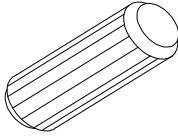
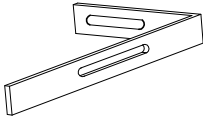

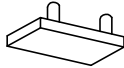
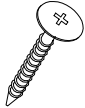
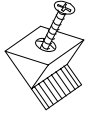
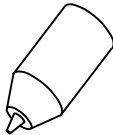
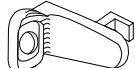

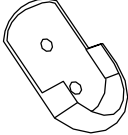
			
Ø6.5x36.5mm A-18	Ø15x16mm B-16	Ø15x22mm B2-14	Ø20 C-28
			
Ø8x30mm D-40	Z-2	Ø3,5x16mm F-36	G-10
			
Ø3.0x20mm K-20	J-30	KL	M-8
			
Ø6.3x11mm N-8	S1-4	Ø3,0x13mm S2-4	T-6
			
2276mm Q-2	WV-16	L-872 DR-2	AZ-4

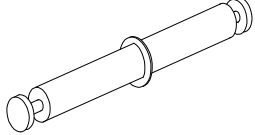
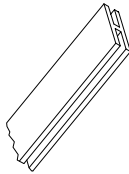
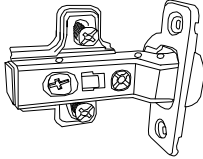
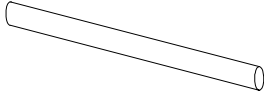
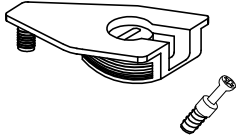
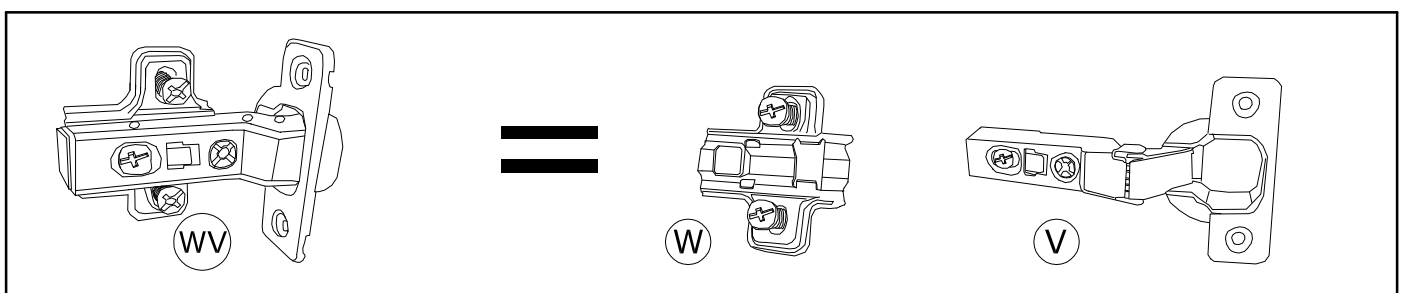

1.



Ax14



Gx4



S2x2



S1x2



Wx8

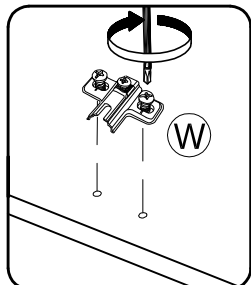
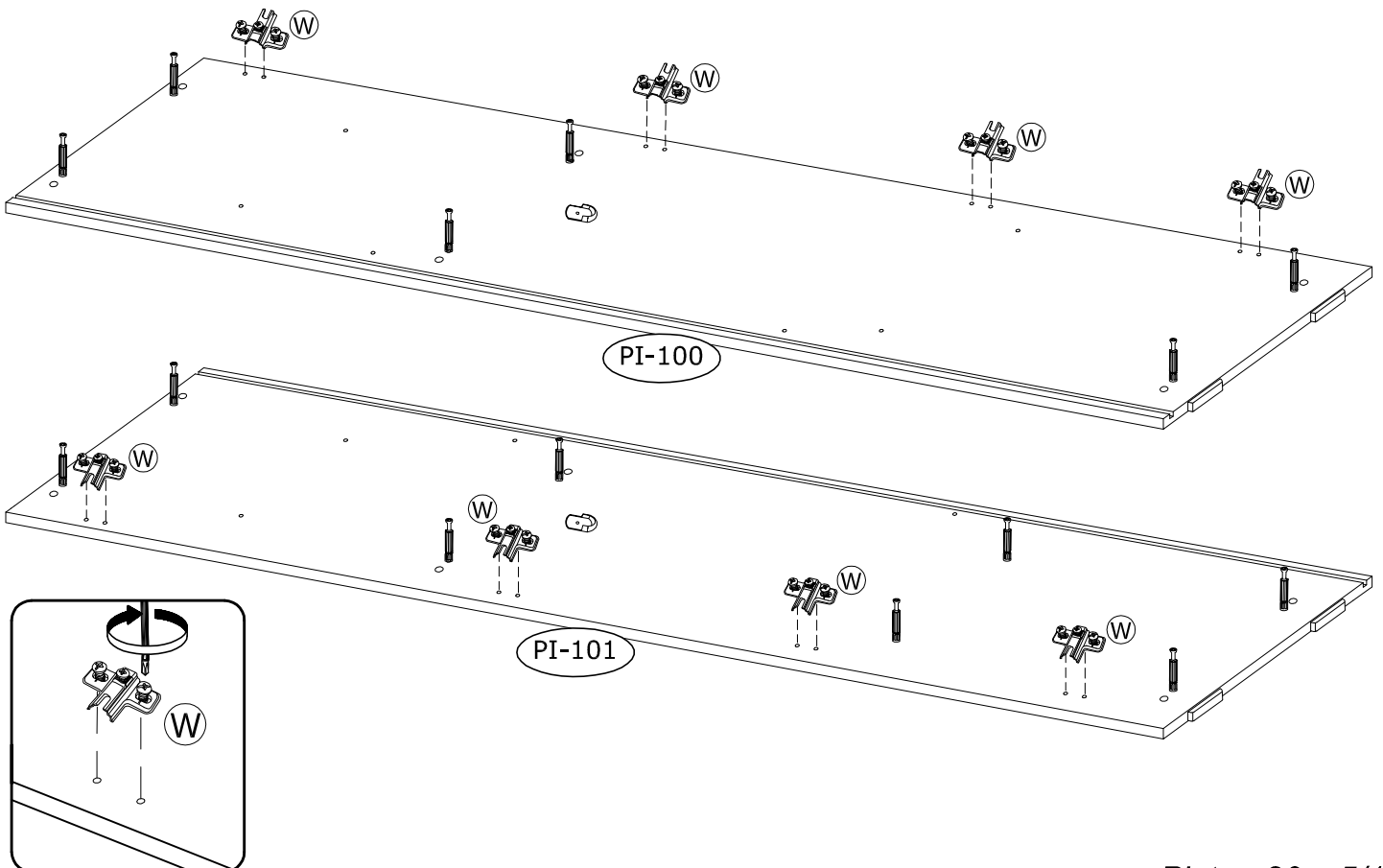
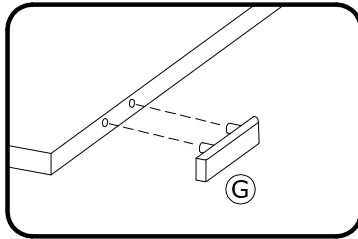
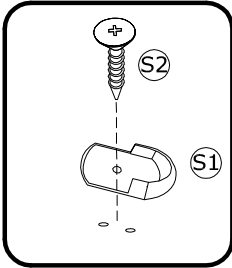
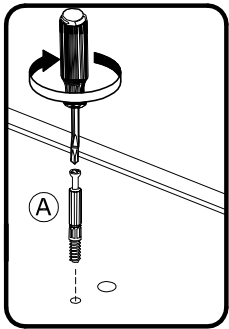
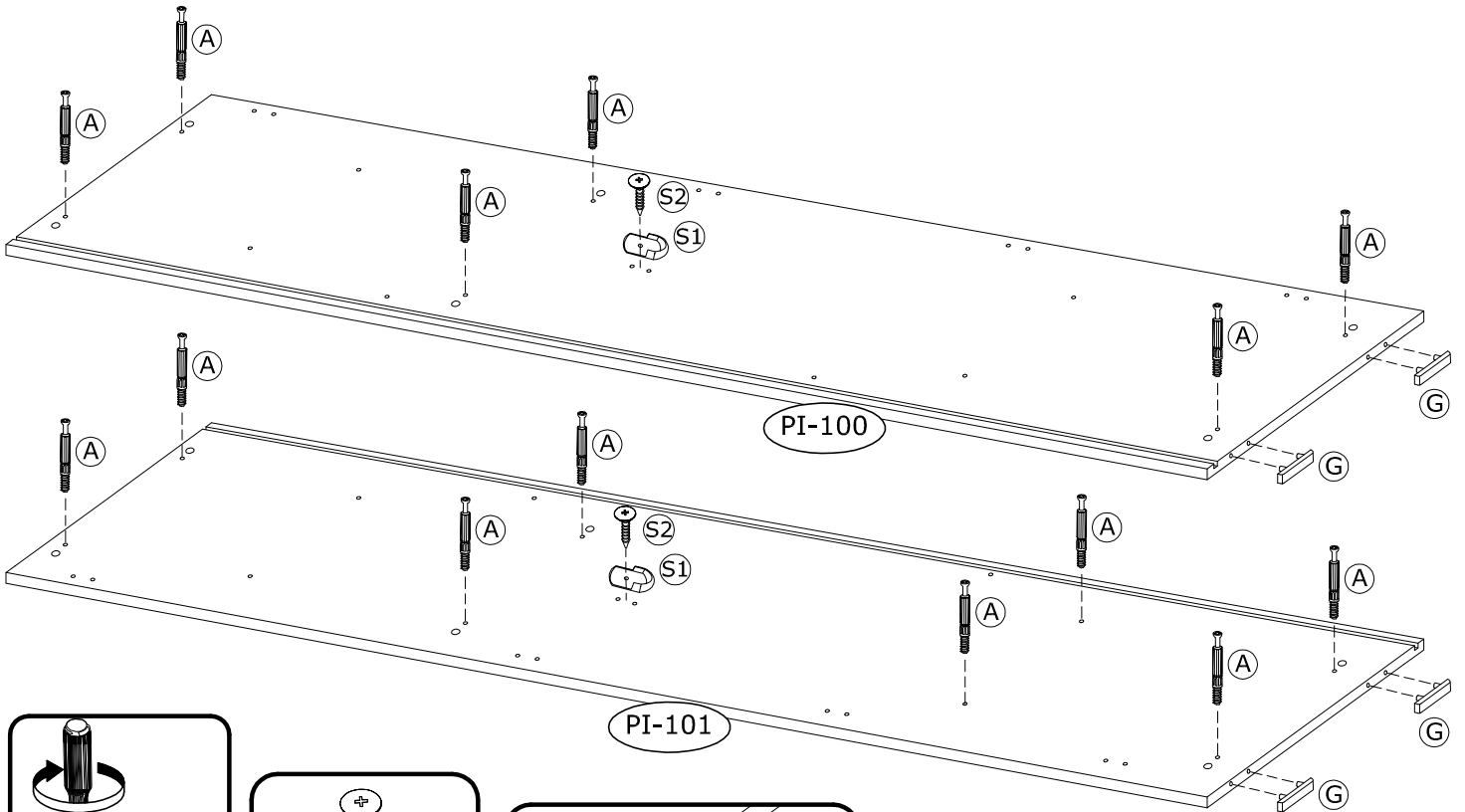

2.

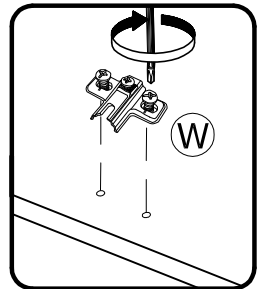
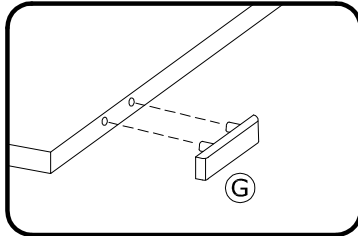
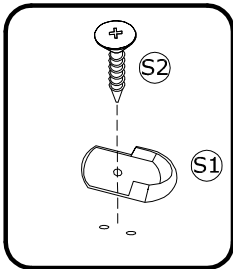
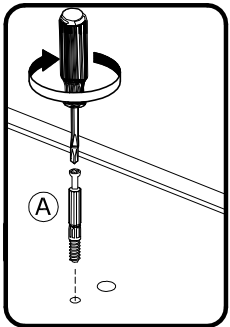
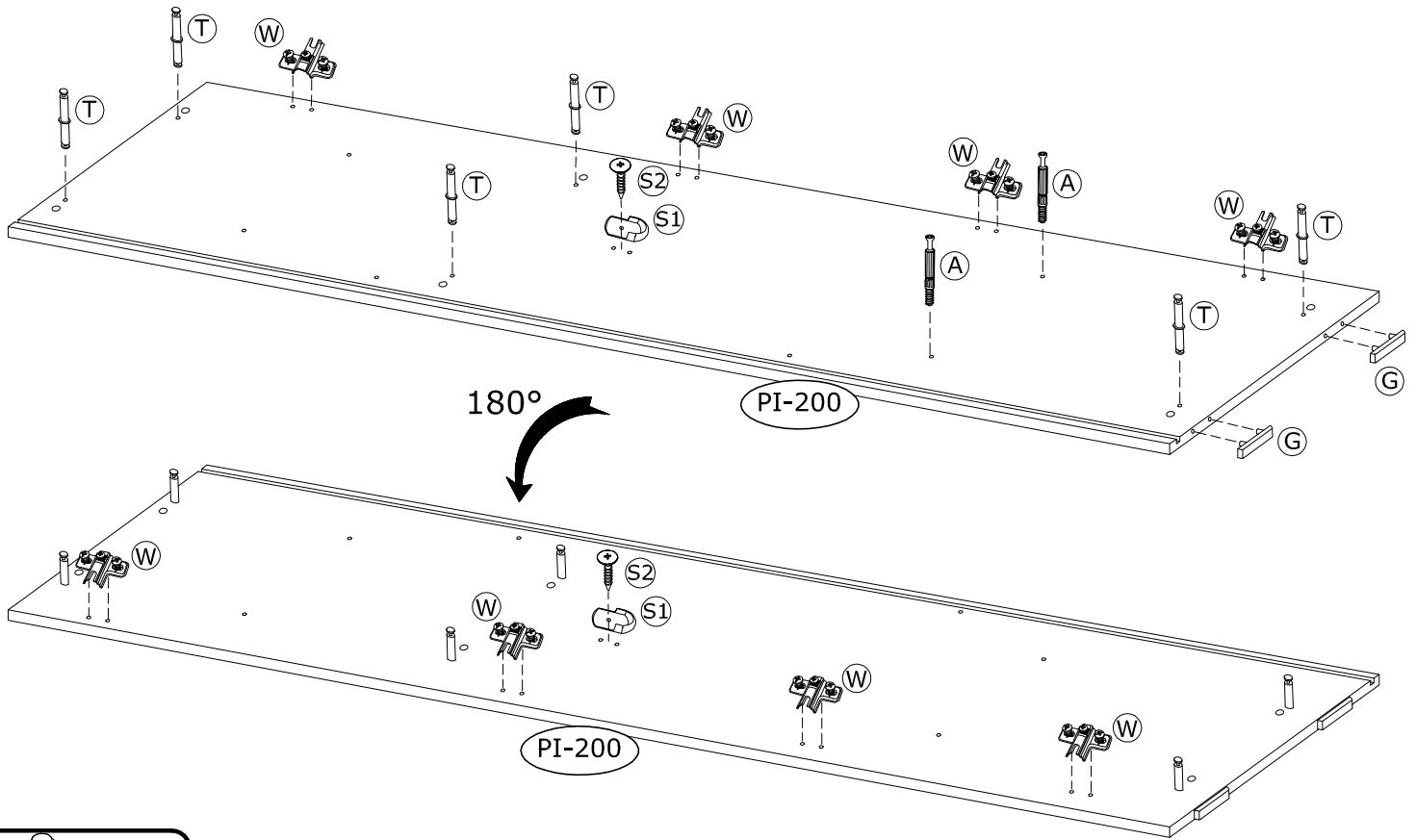
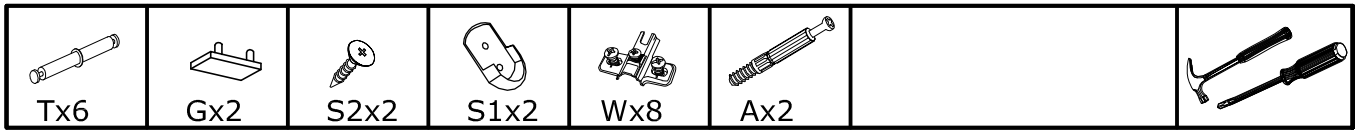

3.

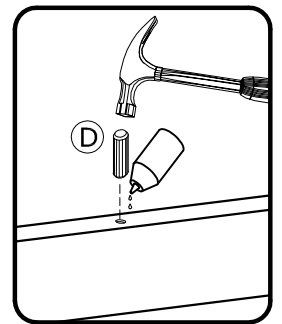
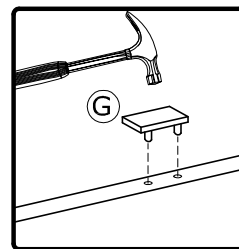
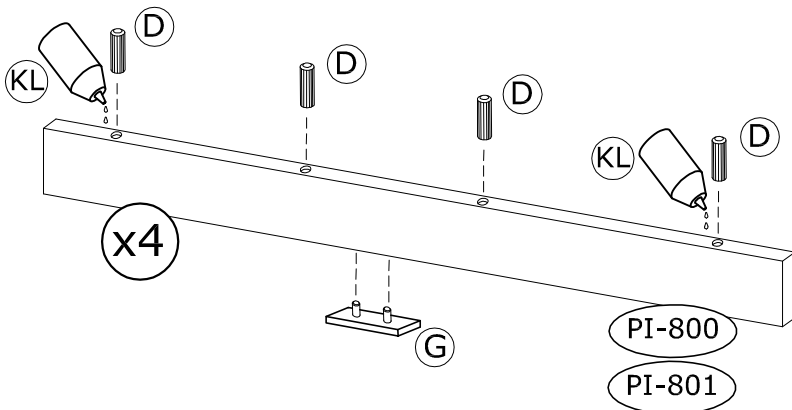

4.



Bx8



KL



AZx2

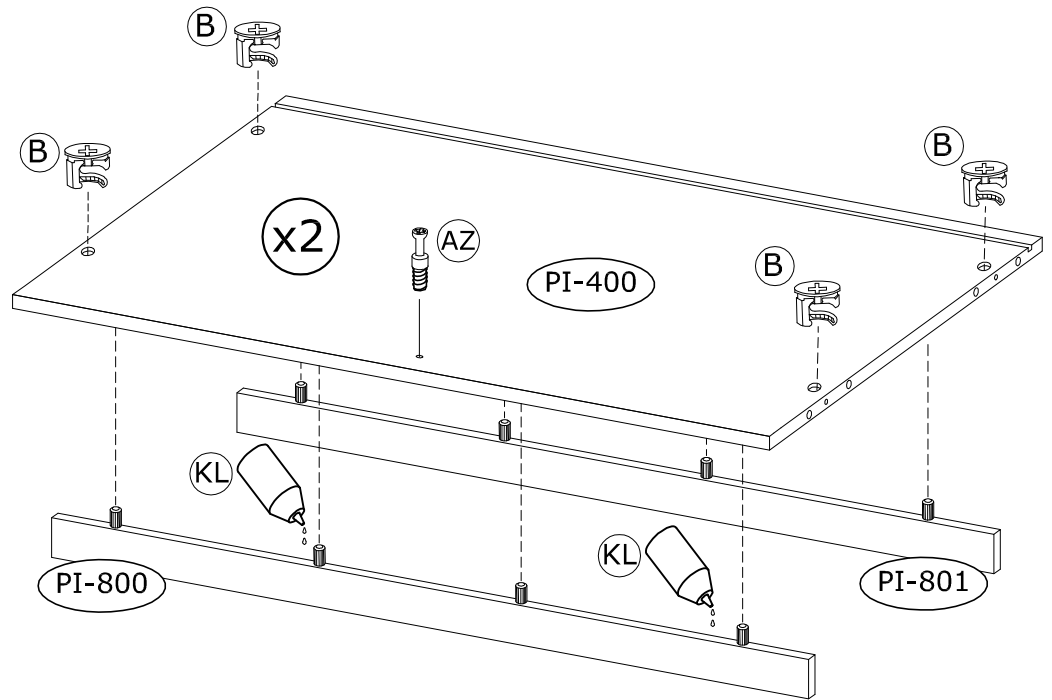
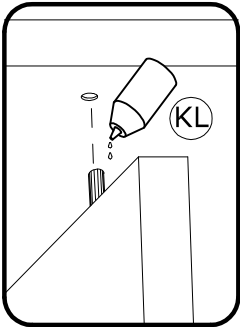
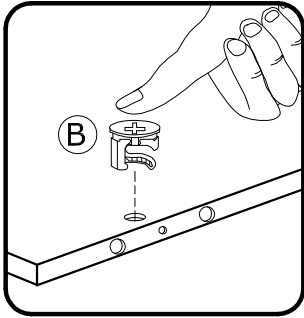

5.



Bx8



AZx2

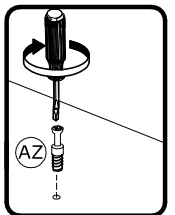
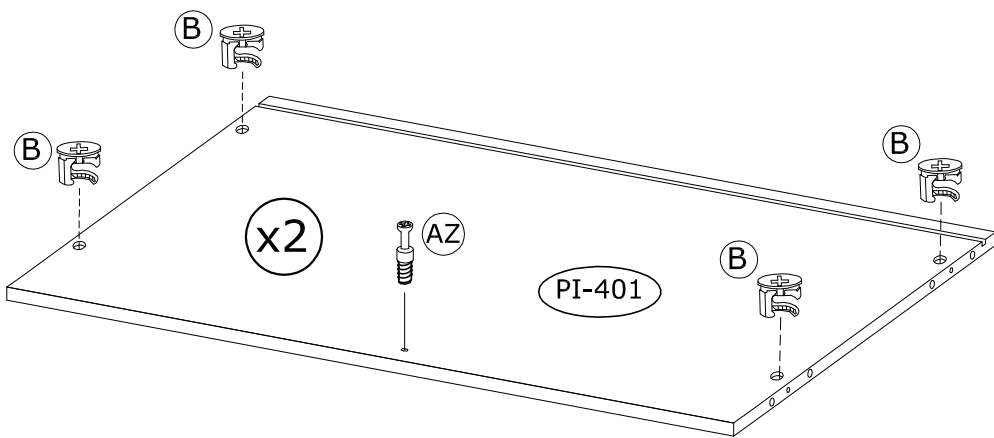
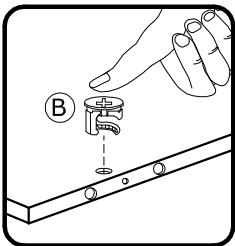

6.



AZx4

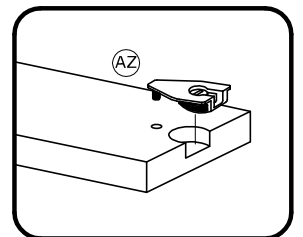
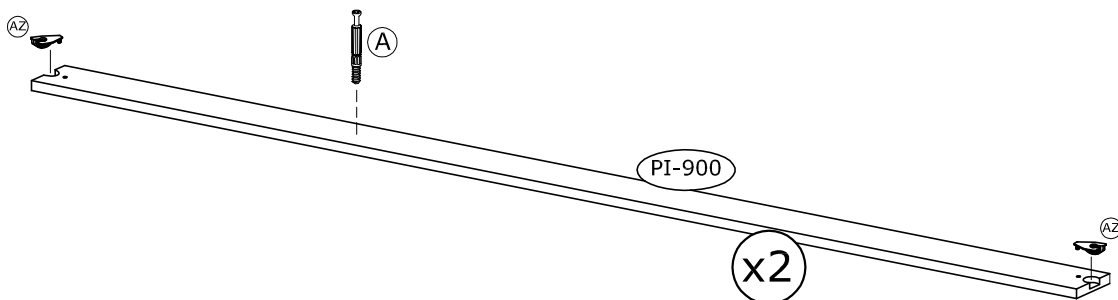

7.

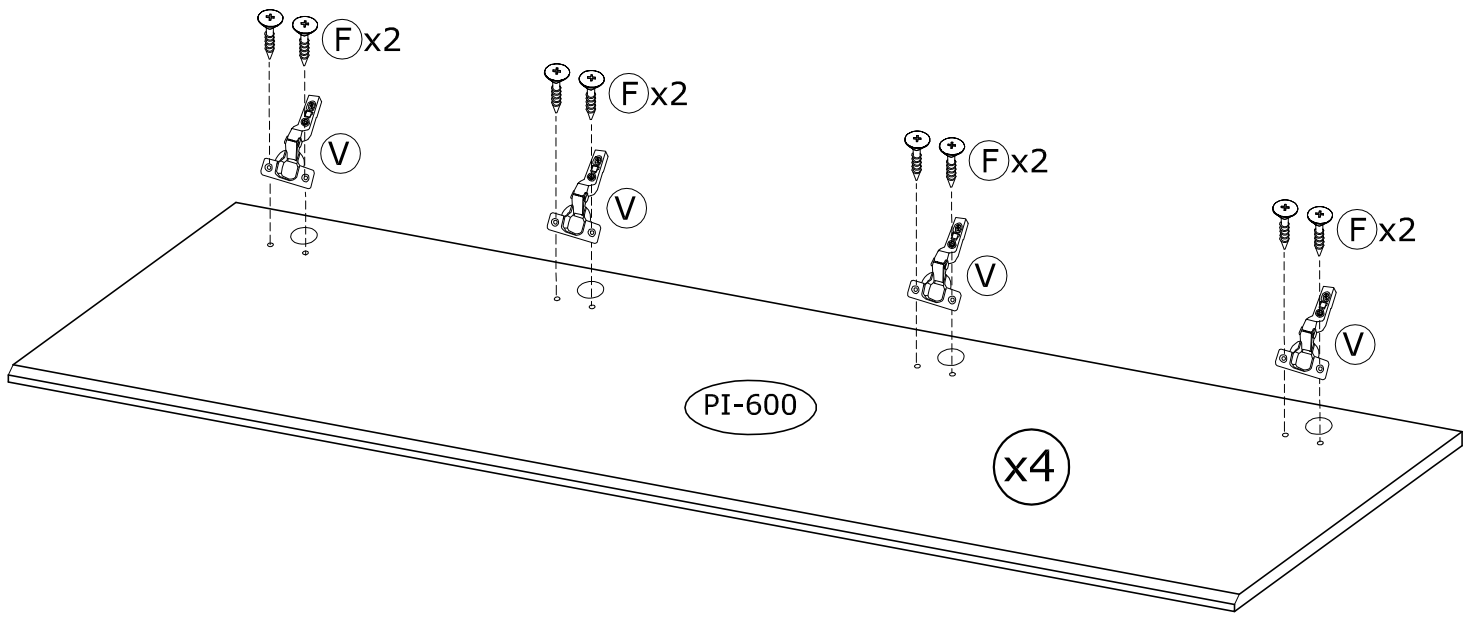

8.

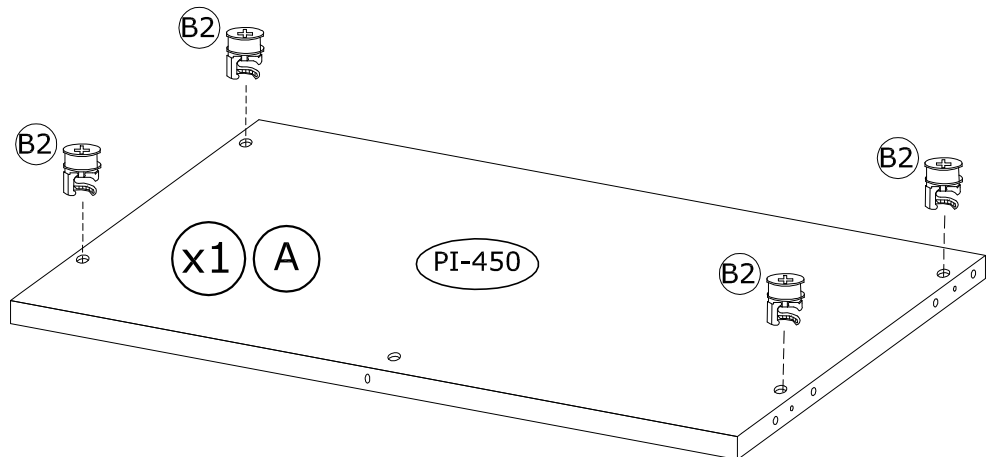
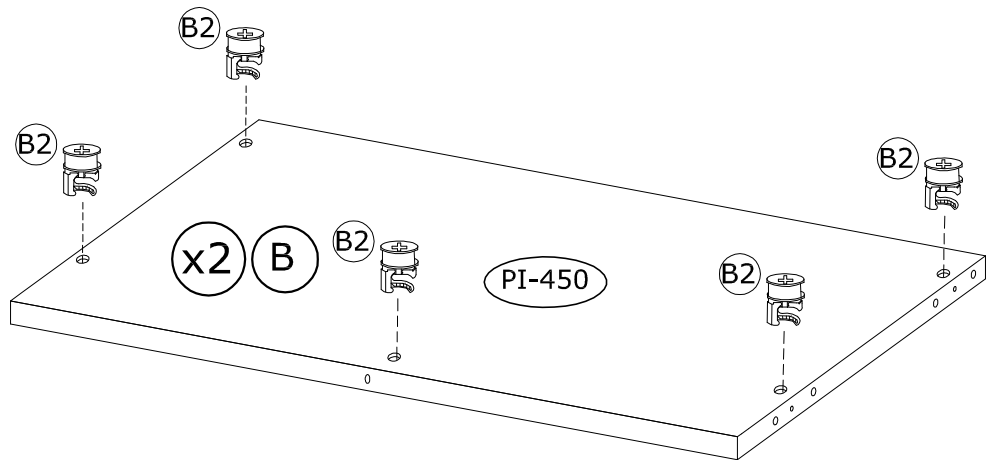
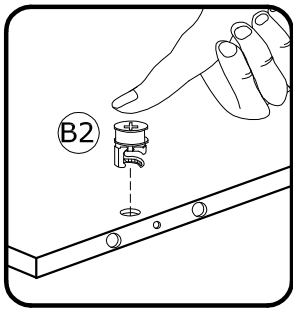

9.

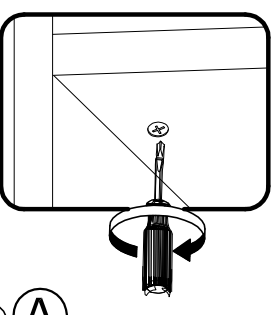
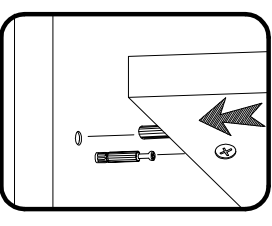
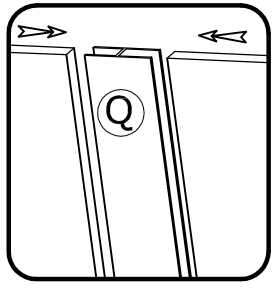
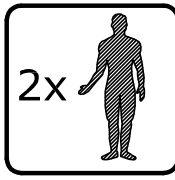
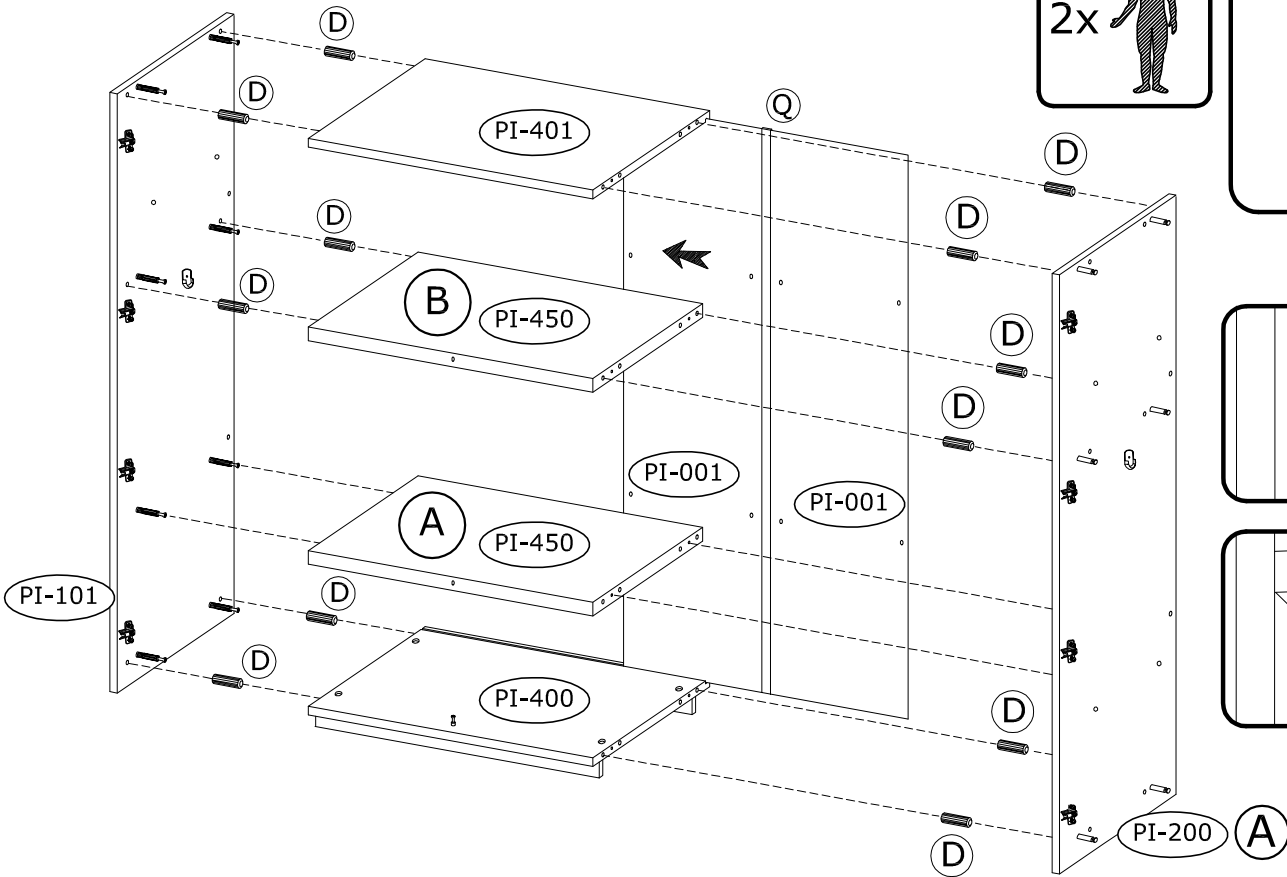
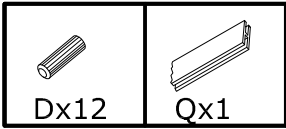

10.

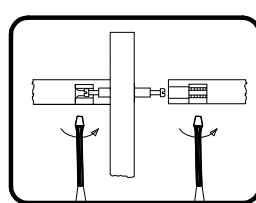
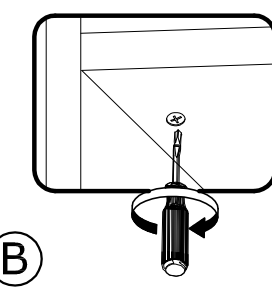
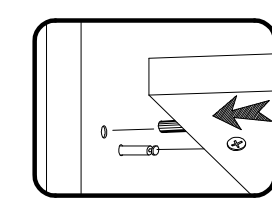
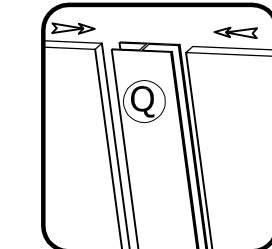
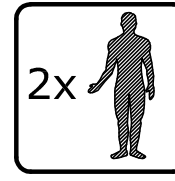
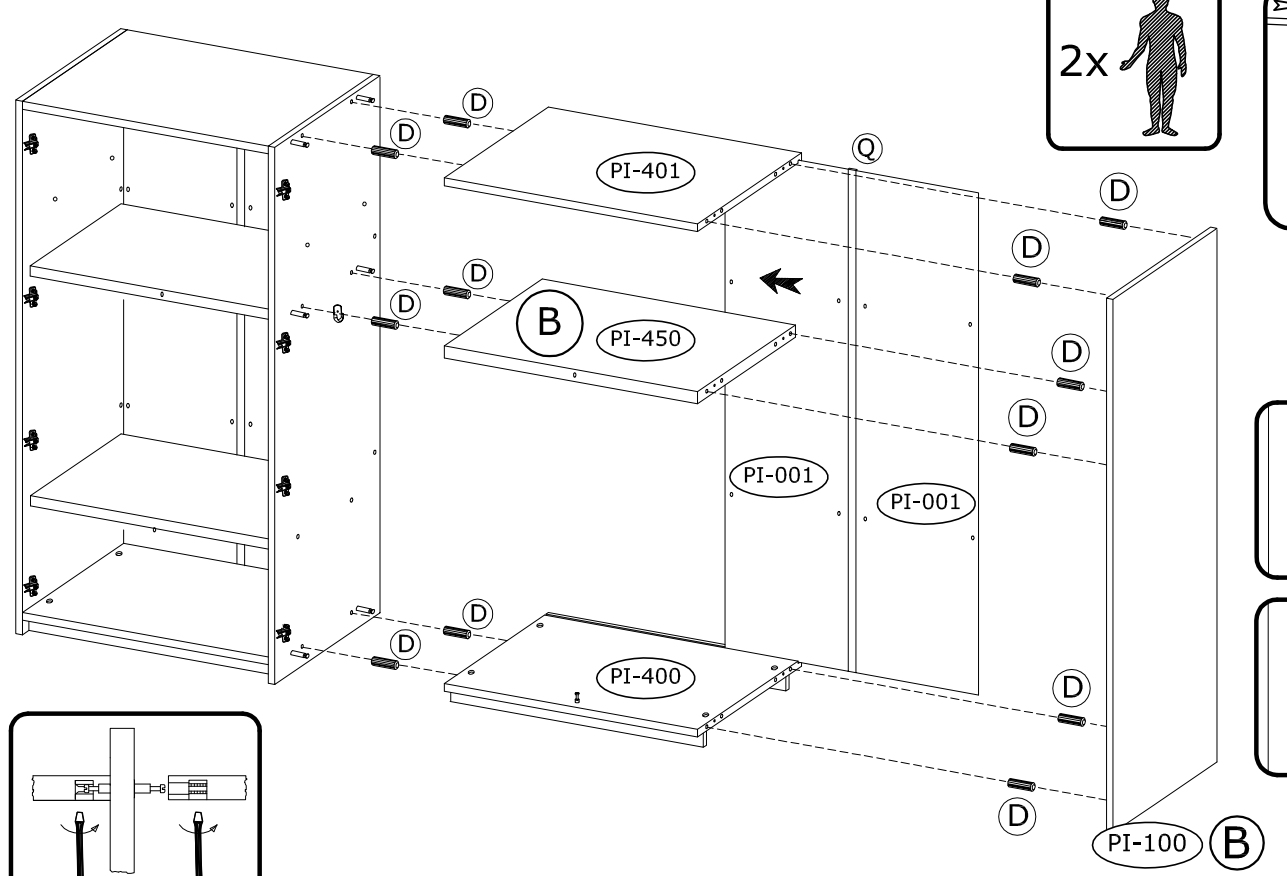
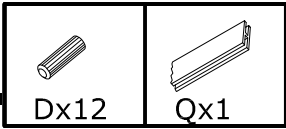

11.



Mx8



Nx8

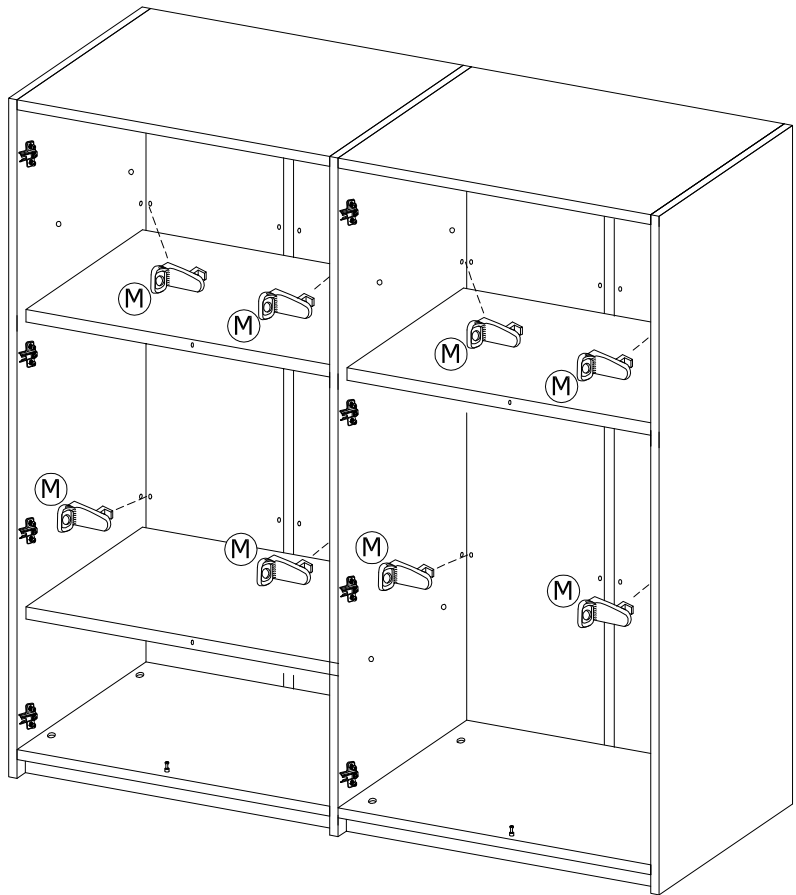
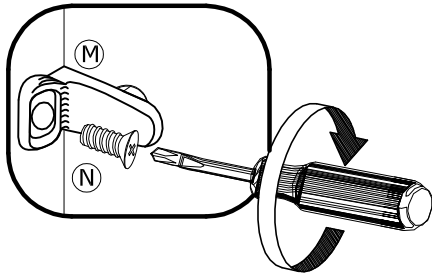
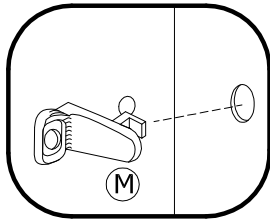

12.



Jx30



K-20

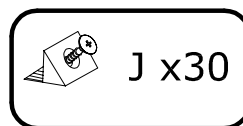
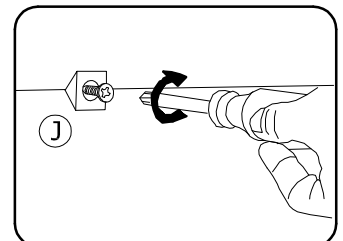
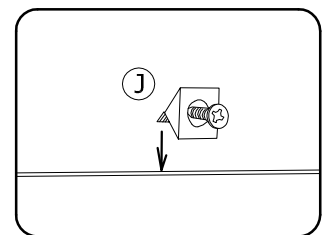
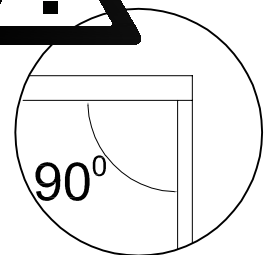
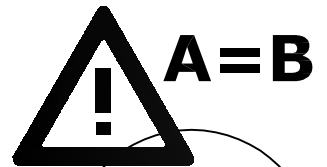
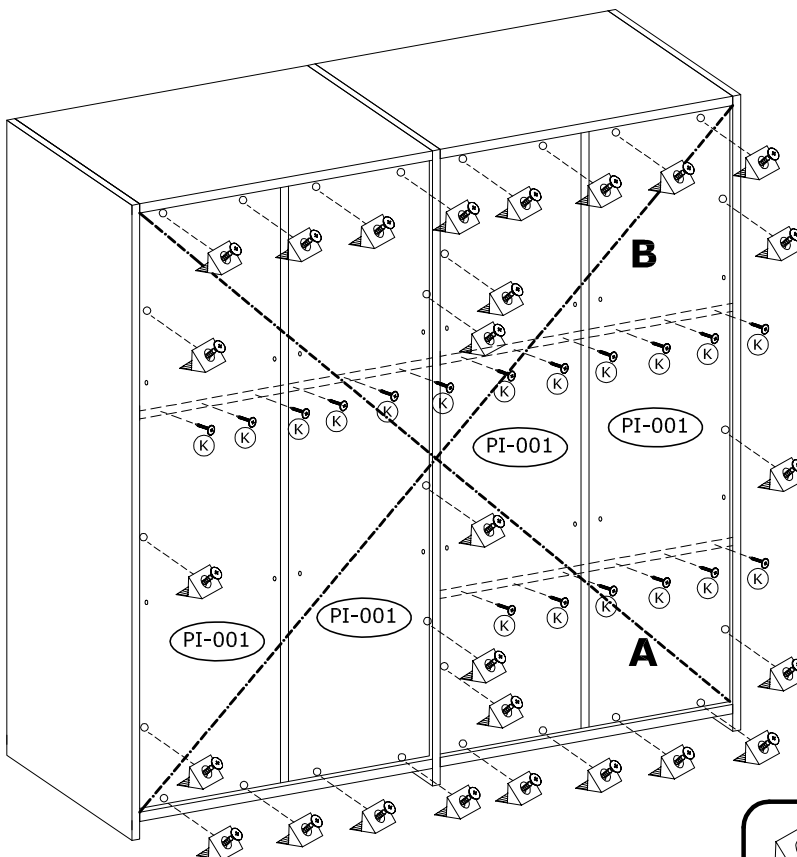

13.

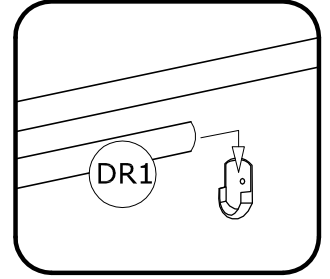
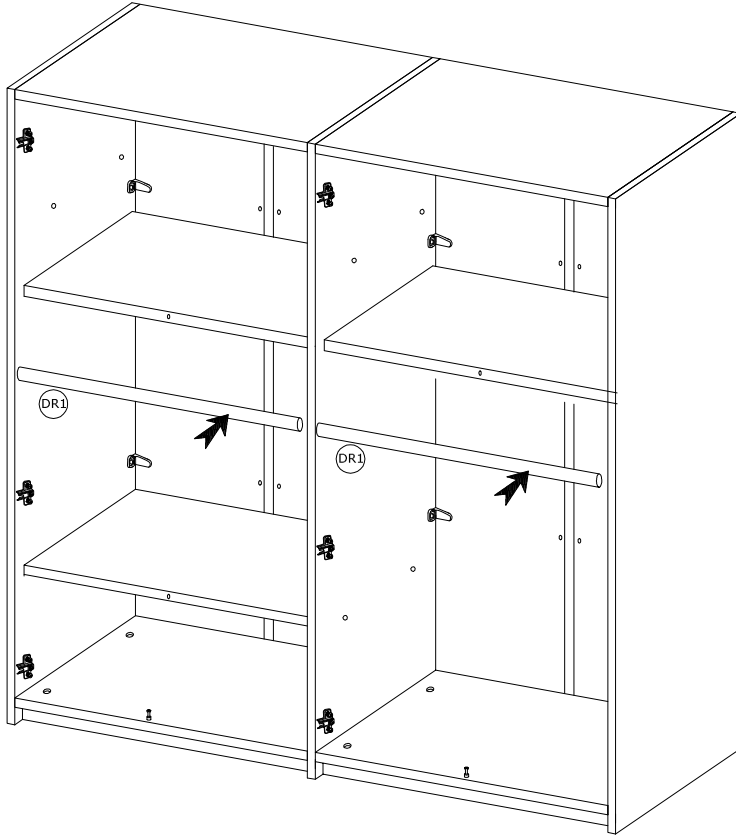
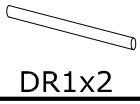

14.

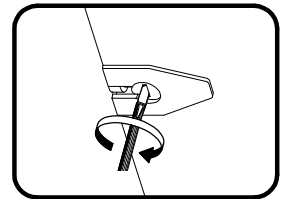
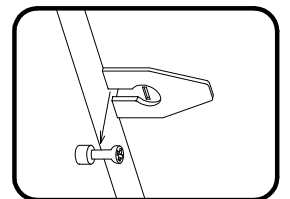
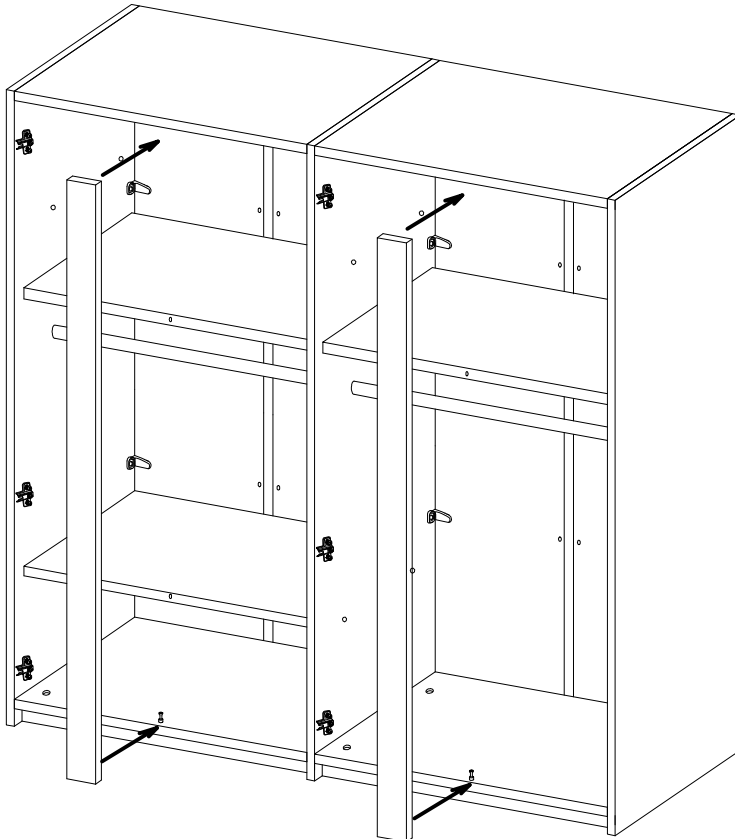

15.

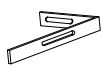

Z-2



I-4

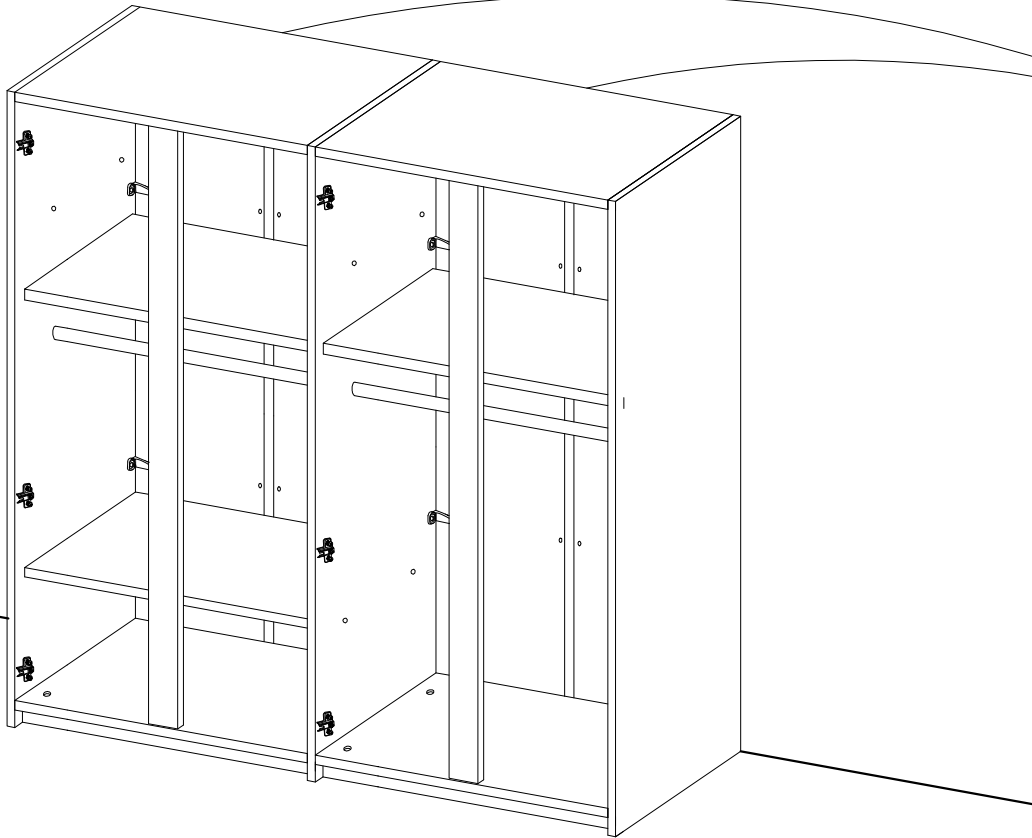

16.

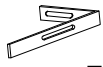

Z-2



I-2

